

Integration of Decentralized Generations into the Distribution Network- Smart Grid Downstream of the Meter

*Sidi Salah ECH CHARQAOUY**[‡], *Denoun SAIFAOUY**, *Omar BENZOHR**, and *Asmaa LEBSIR**

* Physics department, Faculty of Sciences - Casablanca AC, Hassan II University, 20100 Casablanca, Morocco;
(echcharqaouy@gmail.com , ddsaifaoui@gmail.com , omar.benzohra@gmail.com , asmaalebsir4@gmail.com)

[‡]Corresponding Author; *Sidi Salah ECH CHARQAOUY*, 20100 Casablanca, Morocco, Tel: 00 212 661 31 93 55,

Fax: 00 212 522 34 05 44, echcharqaouy@gmail.com ,

Received: 08-12-2019 Accepted:20-01-2020

Abstract-Overcoming the integration constraints of intermittent and predictable renewable energy production are one of the main distribution systems operators' objectives. Several solutions have been implemented and others are in the experimental phase, but most of these solutions are part of smart grid strategies. It is within this framework, that we have developed a solution that involves implementing a smart grid system downstream of the meter that will scratch onto the smart grid of the network manager upstream of the meter to complete it and give it a lot of flexibility. This system allows one to calculate the production forecasts of the renewable energy plants, to take charge of the load shedding priorities decided by the customer, to establish the optimal power supply scheme, to order the cut-off devices of the customer's internal installation for the execution of the optimal scheme, to communicate with the Distribution System Operator, to ensure compliance with its directives with regard to active and reactive powers to be injected on the distribution network by acting on the receivers and capacitors and responding to requests for deletion and making the necessary arrangements in such cases.

Keywords: *Smart Grid, Smart Meter, Renewable energy, Prediction, Distribution network.*

Abbreviations and acronyms

DSO	: Distribution System Operator	P_{pv}	: Active power produced by the PV plant
HVA	: High Voltage level A (from 1000 to 50 000V)	P_{wp}	: Active power produced by the wind power plant
IED	: Intelligent Electronic Device	P_{cs}	: Charging power of batteries storage
LV	: Low Voltage (from 50 to 1000V)	P_{ii}	: Active power called by internal installations of consumer-producer
ONEE	: Moroccan National Company of Electricity and Water.	P_{at}	: Active power - threshold set by the DSO
RDG	: Renewable Dispersed Generation	Q_{rt}	: Reactive power- threshold set by the DSO
P_{ap}	: Active power produced by the RDGs of consumer-producer	P_{as}	: Available power in batteries storage
Q_{rp}	: Reactive power produced by the RDGs of consumer-producer	PERG	: Global Rural Electrification Program (Morocco)

1. Introduction

For several years now, public electric utilities have been turning to smart grid technology, on the one hand, to deal with power grid management and operation and to meet

new consumer demands on the other. However, overcoming the integration constraints of intermittent and predictable renewable energy production remains one of the primary objectives of this action [1,2].

The effort to be deployed by the Moroccan National Company of Electricity and Water (ONEE) remains more important. Indeed, more than 70% of the Moroccan distribution network was developed under the Global Rural Electrification Program (PERG) in order to increase the country's rural electrification rate from 18% in 1995 to more than 95% in 2010 (Morocco's current rate is 99.53%) [3].

To achieve this goal, a cost reduction policy was adopted to carry out the work of this program, which resulted in waivers of standards, guidelines and instructions. As a result, this network has many weaknesses today. Among others, an excessive average length per High Voltage level A power line (HVA : from 1000 to 50 000V) of about 199 km, an average length per Low Voltage power line (LV : from 50 to 1000V) of 2.3 km [3], a tree structure dominated by small cables, the adoption of a structure in cascade low size and a very simple protection plan.

like all Distribution System Operator (DSO), ONEE is focusing its efforts today in three areas. The first concerns distribution optimization, which includes the efforts of the utility to improve the efficiency and reliability of the demand for transmission and distribution systems. The second is optimization focused on solutions allowing the consumer to better manage the evolution of the supply and the demand, which constitutes an equation on the whole of the distribution network. Finally, the optimization of the assets, which is nothing other than the application of monitoring and diagnostic technologies to help manage the healthcare network and increase the lifespan of its components [4,5,6].

This network is inevitably destined to undergo a profound change in the coming years. In fact, in the context of the development of intermittent and probably diffuse renewable energies, the development of new electrical uses and the need to optimize its efficiency, it will be necessary to restructure and, above all, modernize it by providing it with a control system, automatic control and measurement as well as bidirectional communication. In short, it will be necessary to make it smart [7].

The present work, which is part of this framework, aims to solve problems that are conflicting between the DSO and the consumers-producers. We mention: the erasure, absorption or generation of the reactive power or the limitation of its production in active power. It also helps to solve some of the problems of integrating Renewable

Dispersed Generation (RDG), including disruption of the voltage plan and allowing these consumer-producers to respect the network manager's requirements for power quality and to choose the optimal production and consumption configurations according to energy availability.

The application called "TAKATI", intended to manage the private network of tertiary producer-consumer (industrial or agricultural), is a computer system that allows supervision of all the systems that are installed (energy supply, lighting, air conditioning, ventilation and heating, different areas of industrial or agricultural consumption, renewable energy generation plants, etc.). It mainly allows the production forecast of renewable energy plants, based on weather forecasts, to address offloading priorities outlined by the customer, to establish the optimal power supply scheme, to order the cut-off devices of the customer's internal installation for the execution of the optimal scheme, to communicate with the Distribution Operator system (DSO), to ensure compliance with the its instructions with regard to the active and reactive powers to be injected into the network by acting on the receivers and capacitors and to answer the requests of deletion and to make the necessary arrangements in such cases. The objective is to have a global view of the energy system of the private network and to know what is going on especially in relation to, the states (equipment, position, return of an order, ...), measurements (temperature, operating time, number of failures) and alarms (failure, abnormal stop, measurement exceeding a threshold).

2. Description of the solution and working principle

The solution adopted is based on an intelligent electronic device (IED). This device which is equipped with nozzles for analogy and digital inputs and outputs, manages current, voltage and temperature sensors. It controls devices which manage and relay devices for shutting down and restoring electrical circuits.

Figure 1, below, illustrates the two circuits, electrical and communication and the most important components:

- Microprocessor board equipped with several input and output nozzles
- Sensors for current, voltage, temperature, etc.
- A Protocol and communication ports
- Devices and devices of electrical power cuts
- Smart, communicating bi-directional energy meter [8]
- Electric energy meters by center or consumption area

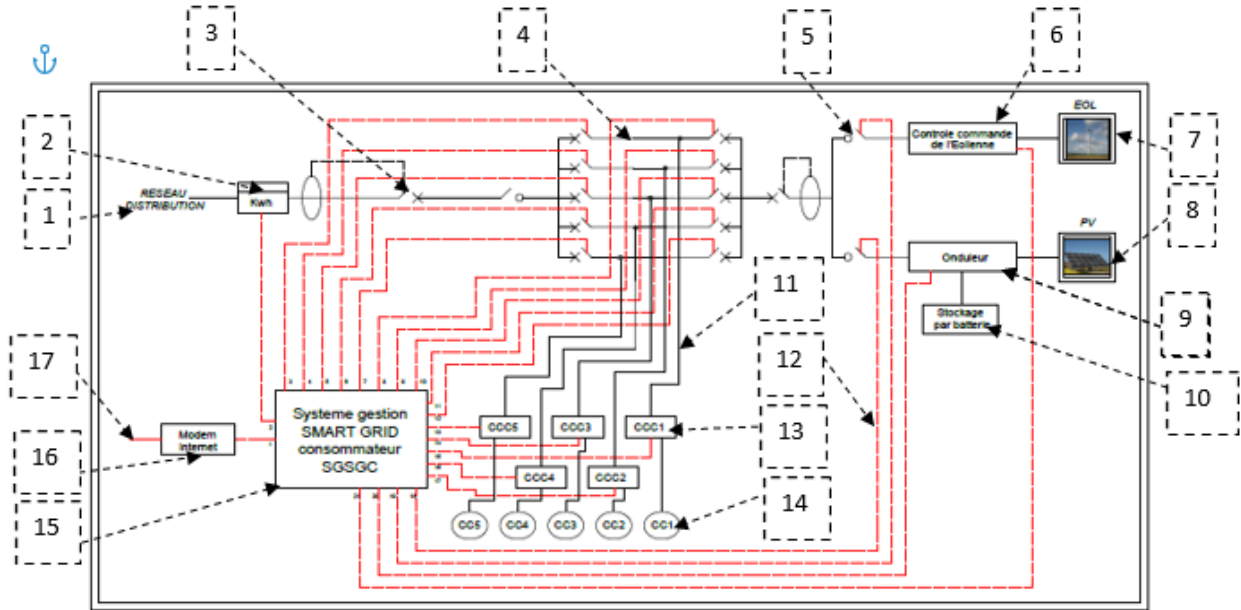

Fig. 1 Synoptic scheme of electrical and communication circuits

Reference Numbers	Designation
1	Supply from the distribution network (distribution feeder)
2	Smart meter
3	Differential circuit breaker (Distribution network side)
4	Switch box
5	Differential circuit breaker (RDGs side)
6	wind turbine control box
7	Wind power plant
8	PV power plant
9	Inverter
10	Storage system
11	—— Electrical circuits
12	----- Communication Circuits
13	CCCi: Control Box of the Consumption Center number i
14	Consumption Centre number i
15	“TAKATI” hardware system (IED)
16	Internet modem
17	Communication network

The software is designed to be user-friendly and to inform the system operator about the state of the installations and the process and to allow it to follow the electrical parameters and power prediction values.

While respecting the security standards of smart grids, in particular the confidentiality of system information [9]

Upon installation, the system must be configured by introducing the characteristics of the site, the RDGs, the receiving facilities and the braking system. The operator, in turn, can at installation and whenever it is necessary,

proceed to the secondary configuration by introducing load shedding priorities.

As illustrated by the diagram of algorithm in figure n° 2 a, b and c, two cases arise:

The sector is out of order ($U_N=0$ where U_N is the voltage value at the connection point): the system disconnects the internal installations of the sector (as showed at figure 3 a and b). Then, if we have full charged batteries, several cases arise:

- the production power is sufficient to cover all the consumption ($P_{ap} - P_{ii} > 0$) and exceeds the threshold allowed by the DSO ($P_{ap} - P_{ii} > P_{at}$) then the application starts the braking system, if ($P_{ap} - P_{ii} < \text{or} = P_{at}$) the producer sales energy.
- If ($P_{ap} - P_{ii} < 0$), and the producer does not want to buy energy then the system activates the load shedding program else the remainder of energy is provided by the sector.

The sector is in service: the system controls the instructions of the DSO. If the DSO orders an erasure then the system compares the output power and the one called by the receivers if the latter is lower than the first $P_{ap} - P_{ii} > 0$, so, it disconnects the internal installations and operates in an isolated system and activates the system braking. In the case where the erasure is not requested, the DSO sets a threshold for the active power allowed for export P_{at} . The system checks whether $P_{ap} - P_{ii} - P_{cs} < P_{at}$. If yes, the system closes all contactors and the customer-producer exports energy to the network, if not, the system uses braking software.

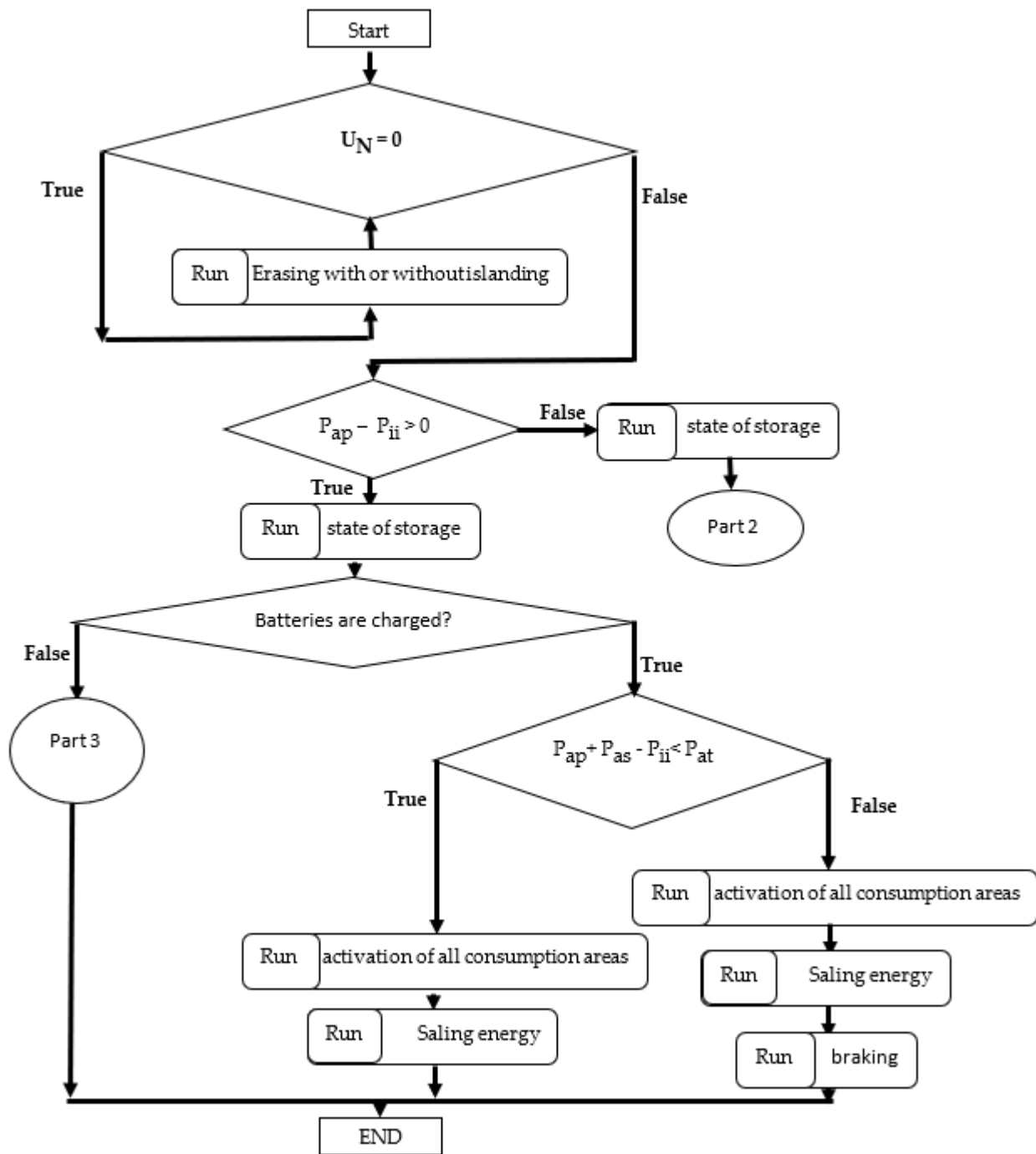

Fig. 2 -a: Diagram of algorithm “OPTIMISATION”, Part 1

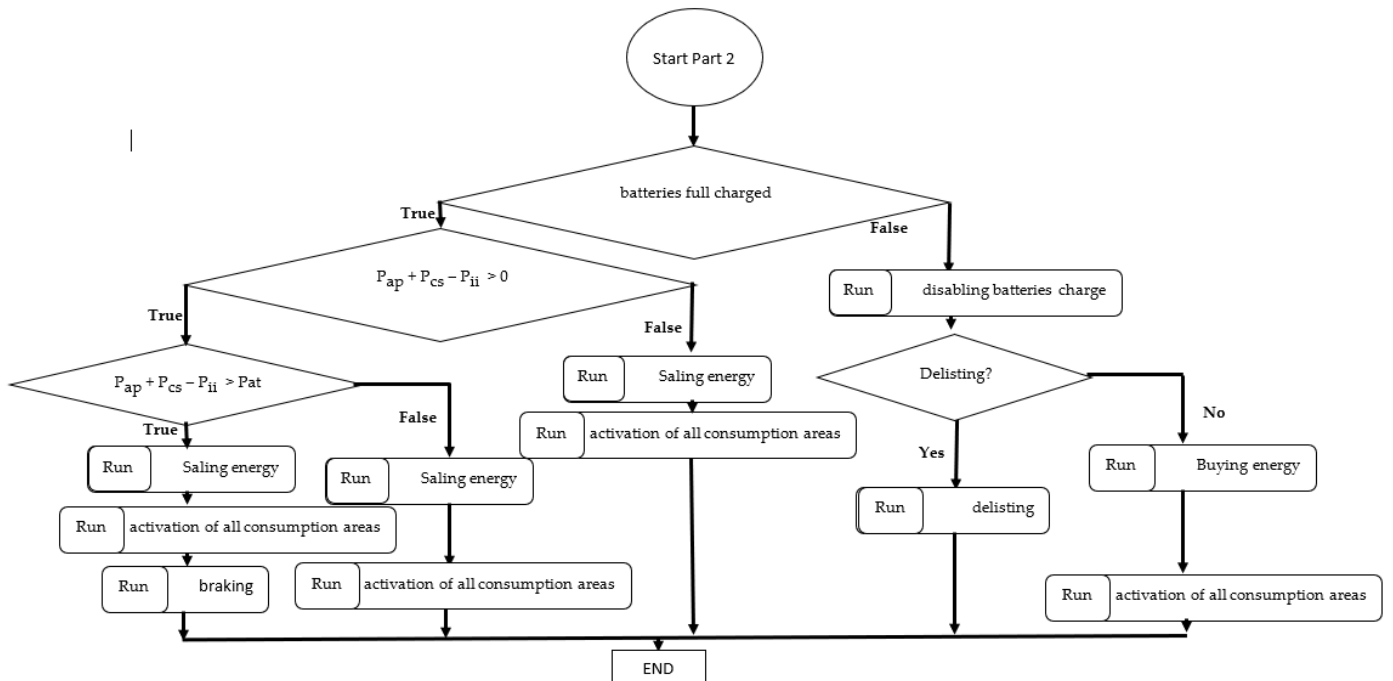

Fig.2 -b Diagram of algorithm “OPTIMISATION”, Part 2

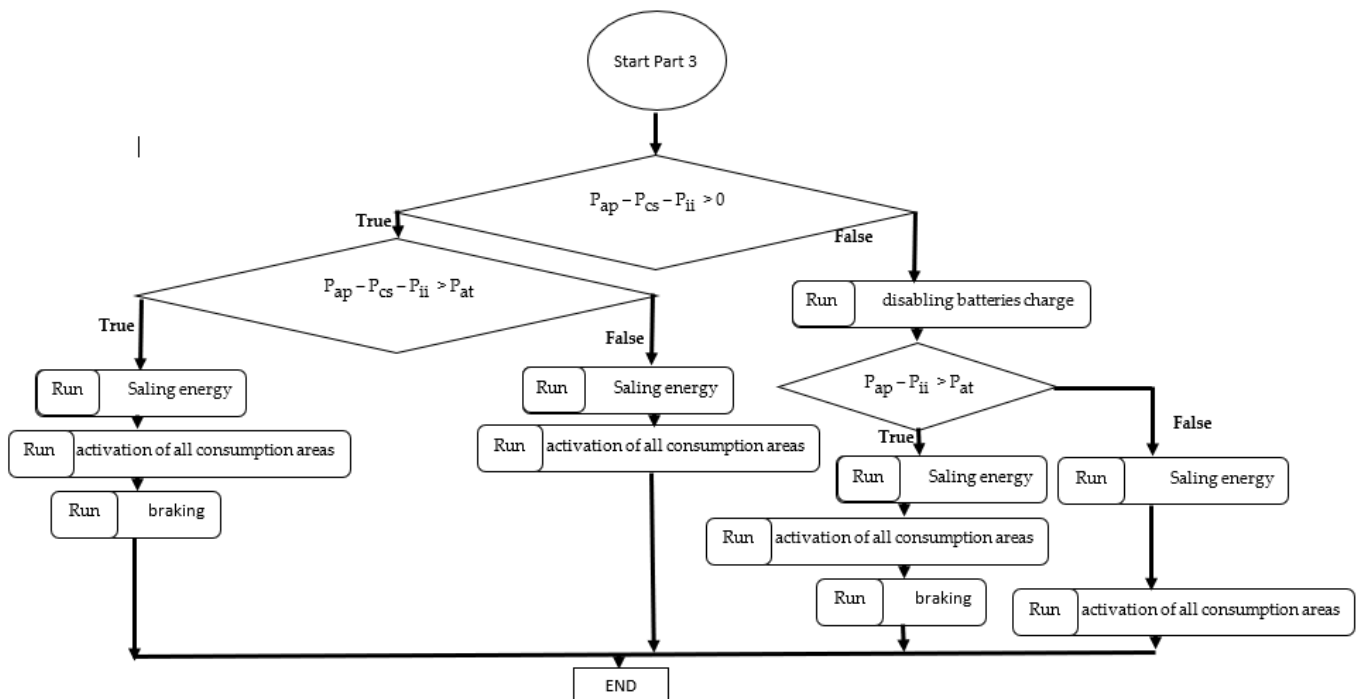

Fig. 2 -c: Diagram of algorithm “OPTIMISATION”, Part 3

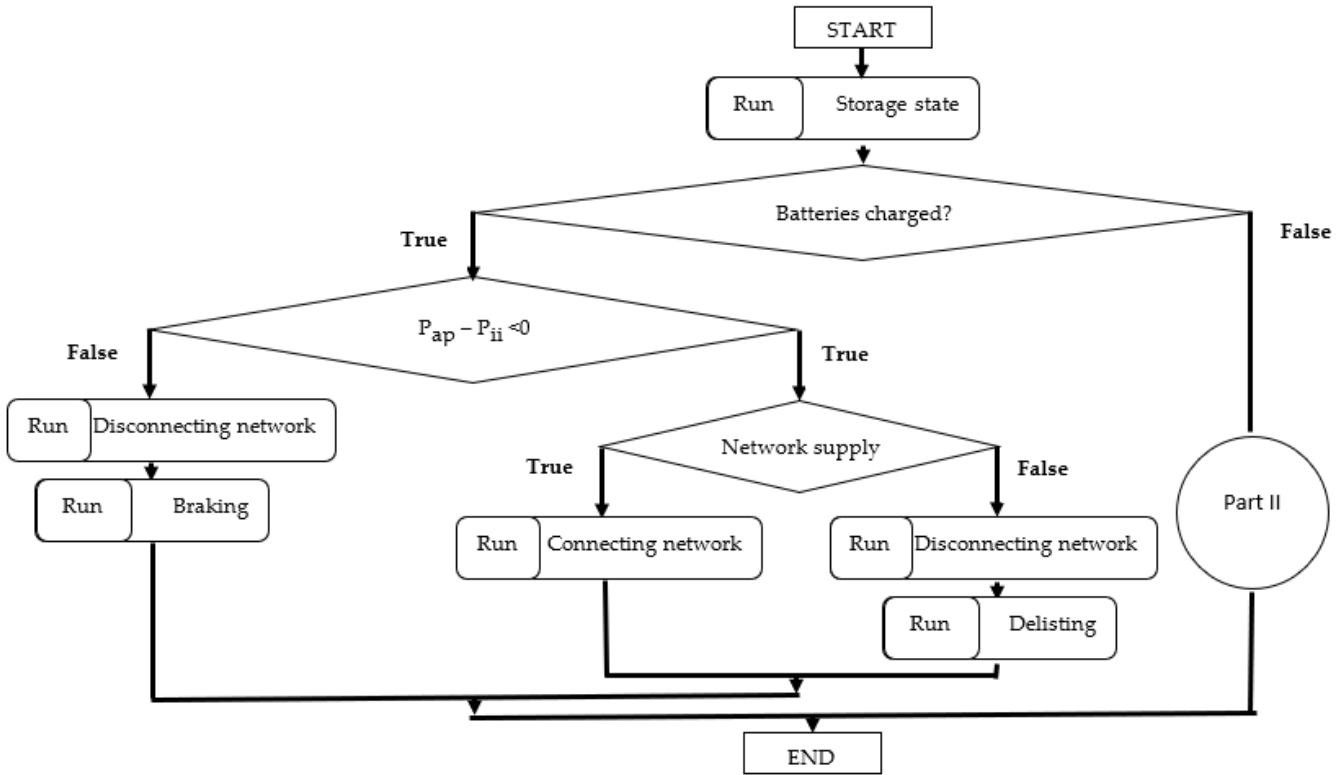

Fig. 3-a: Diagram of algorithm “Erasing with or without islanding”, Part I

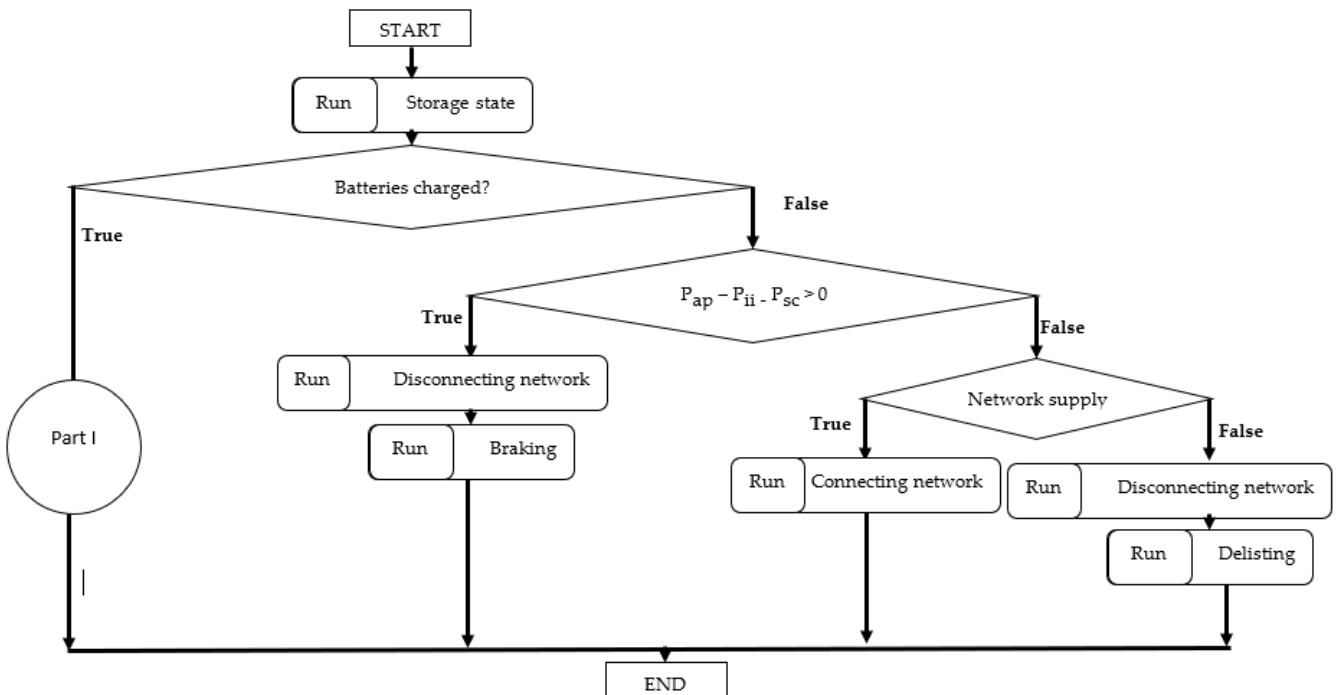

Fig.3 -b: Diagram of algorithm “Erasing with or without islanding”, Part II

The program in its course proceeds to the adjustment of the reactive power by acting on the capacitors installed for this purpose. Also displayed are the values of measured

quantities, monitoring indicators and status of installations and switching devices.

3. Calculation of forecasts

The renewable energies taken into consideration by TAKATI are wind energy and photovoltaic solar energy, the integration of these energies is evolving: in 2050, wind energy should provide 12% of global electricity consumption [7], while PV energy should provide 11% [7]. The integration of the electrical energy generated by these plants into the electricity grids is not without its problems due mainly to the variability and volatility of renewable resources. The quality of the energy production forecasts of wind farms or photovoltaic installations has a direct impact on the economic functioning of electrical systems [10,11] and on the economic results of plants whose energy is sold on the markets electricity [7]. The size of the economic stakes has strongly contributed to the development of short-term energy forecasting models for wind farms or for relatively large PV plants connected to the grid.

The diversity of forecasting models is a direct result of the diversity of their use. Forecasts can be applied to a single PV or wind system, or can be expanded to govern a large number of systems spread over an extended geographic area. Forecasts may relate to the output power of the systems or its rate of change (also known as the ramp rate). Prediction methods also depend on the tools and information available to operators, such as meteorological station and satellite data, PV or wind data, and outputs from NWP models [12].

The forecasting methods are said to be physical or statistical depending on the approach adopted [12]. In PV systems, for example, the physical approach uses solar and photovoltaic models to generate PV forecasts, whereas the statistical approach relies mainly on past data to "train" the models, with little or no dependence on solar and photovoltaic models [13].

Several data are used to develop solar and photovoltaic forecasts. We cite measured meteorological data, photovoltaic system data, satellite data concerning cloud observation and numerical weather prediction (NWP) models that form the basis of modern meteorological forecasts [14].

The usefulness of these data varies by country and forecast horizon: very short-term forecasts (0 to 6 hours in advance) give better results [14], use measured data, and while numerical the weather becomes essential for predicting horizons beyond about six hours.

For our case and considering the low stake of the error of the prediction model that can be used, we have opted for a statistical model that self-corrects by measuring instantaneous values.

Based on the historical weather data (time series), the weather forecast the model generates the predicted power and the error margins and after measuring the power actually produced the model is powered by the measured values to self-correct.

General Principe of the short forecasting

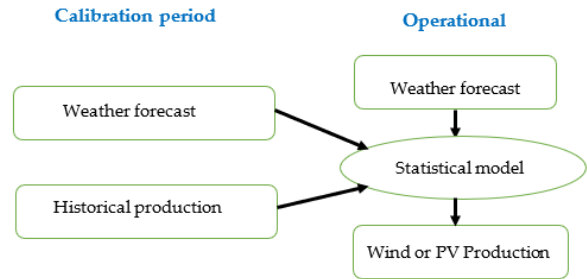

Fig.4 General Principe of forecasting model [15]

4. Participation in maintaining voltage plan case of ONEE’s LV network.

Small and medium-sized producers of renewable energies in Morocco (power between a few kW and a dozen MW) are currently allowed to integrate their productions into the HVA and LV distribution networks [16].

Indeed, many technical problems, due on the one hand to the weaknesses of the network and to the nature of renewable energies on the other hand, hinder the injection of these productions into the network and will limit its capacity of reception. The product of our studies allows, as mentioned above, a viable solution to many of these problems. Maintaining the voltage plan is one of the thorny issues dealt with by our product.

4.1. Current method of adjusting the voltage on the LV network.

According to the standards in force and the ONEE subscription contract for LV customers, the distributors must guarantee a voltage at the customer connection terminals BT which is 230V + or - 10% in single phase and 400V + or - 10% between phases, in three-phase [17].

The value of the voltage in a radial network whose flow evolves in a single direction decreases as a function of the distance to the source and the load (look figure n°5), which requires setting up a method of adjustment that can overcome this problem. The goal of this method is to maintain a voltage profile in the allowed ranges in all nodes of the LV network without resorting to investments.

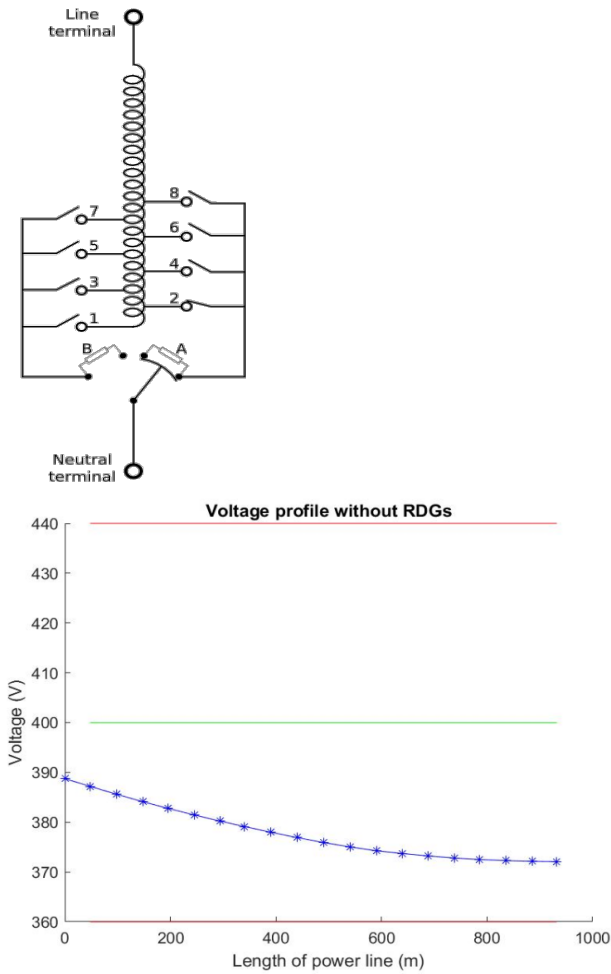

Fig. 5 Voltage profile along a LV feeder without RDG integration

The principle of ONEE's current voltage regulation method is based on seasonal off-load setting on the HVA / LV transformer using the three-position -5%, 0 and + 5% outlets [18], equipping this transformer. Its purpose is to avoid overvoltage - exceeding the normative threshold - at the connection terminals of the first customer in the case of the least loaded profile (minimum load) and to avoid voltage drops - below the normative threshold - across the terminals of the customer connecting the last customer at the end of the line [18].

This method becomes insufficient if the production of a decentralized generator is integrated at a point of feeder. Two cases arise depending on the power consumed by the customers of feeder, the power produced and the connection conditions. So, the voltage plan is either maintained (even improved) or disturbed by the generation of overvoltage (in case of minimal load) Look figure n°6.

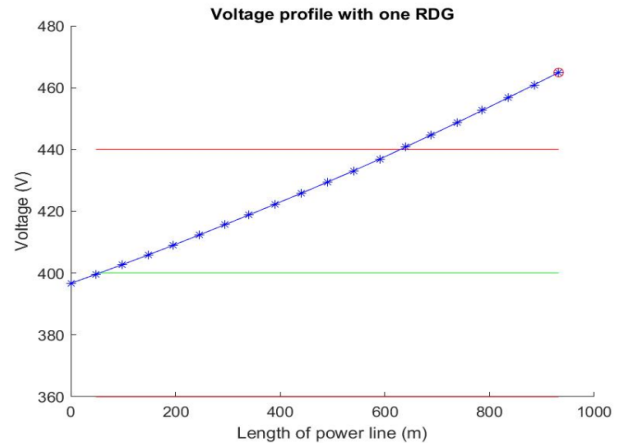

Fig 6 Voltage profile along a LV feeder with injection of one RDG at the end of feeder

The solution that we propose to ONEE and which is currently being tested is based on the generalization of smart meters, the use of HVA / LV transformers equipped with on load tap changer (Fig. 7) and RDGs capable of providing or absorb reactive Energy.

Fig.7- Schematic diagram of on load tap changer

It proceeds through real-time adjustments by acting commonly on the active and reactive power outputs and on the load controller of the HVA / LV transformer. This solution is part of a remote scheduling scheme, which assumes network equipment in addition to smart, communicating, bidirectional meters by concentrators to collect the metering and measurement data at the HVA / LV stations and a communication network. PLC between meters and concentrators and by GSM or radio between the hubs and the control station.

The product of our work complements this system by offering flexibility in setting the level of active and reactive power of EDM with responsiveness, efficiency and accuracy.

Latitude	8°03'53''
Longitude	31°39'10''
Altitude	450 m

To adjust the active power our solution acts on the adjustment of the producer's consumption and the putting on or off of the storage [19,20] and / or braking systems. As for the setting of the reactive power, the system acts on the steps of the capacitor banks to generate or absorb the reactive power.

5. Results of simulation and discussion.

Two types of simulations were performed on this material. A real simulation by installing it on the internal network of a site powered by a PV plant and another by wind turbine.

Three (03) operating periods per day were considered for these simulations:

- Period 1: hollow hours from 00:00 to 06:00
- Period 2: peak hours from 06:00 to 18:00
- Period 3: full hours from 18:00 to 00:00

The peak power of the PV plant is $30 * 25 = 7500$ Wp (Watt-peak), its inclination is 30° .

The wind power plant delivers a maximum power of 10 kW, with a height of 12 m and a rotor diameter of 8 m. the wind speed for starting is 2 m/s.

The operating data are summarized on tables 1, 2 and 3:

Table .4 - Data of the electrical installations

Power Area	Equipment	Installed power
1	Lighting, telecom and data center	1.2 KW
2	Two submerged pumps	6.2 KW
3	4 centrifugal pumps	4 KW
4	Workshop	0.8 KW
5	Machine tools	0.7 KW
Total	Total Coefficient of simultaneity = 0.7	12.9*0.7= 9.03 KW

operating periods	Areas concerned
06:00 to 18:00	1 ; 2 ; 4 ; 5
18:00 to 00:00	1 ; 3 ; 5
00:00 to 06:00	1 ; 3

To allow the installation to respond to the need for variation of the reactive power cabinet is equipped with 12 capacitors KVAR 5, brand large (Legrand Group NV, Kouterveldstraat, 91831 Diegem) and type V540CB. These capacitors are controlled by a XAMAX BR7000 brand regulator modified to be controlled by the system.

Table 1 Geographical data of site

Table 2 Average temperature

Operating periods	The average wind speed (Km / h)
06 :00 to 18 :00	7.3
18 :00 to 00 :00	19.7
00 :00 to 06 :00	7.4

Table 3 Variation of the wind speed

The customer/producer has five (5) feeding areas. Each of these areas contains a set of specific equipment in relation to the activity exercised there (see Table 4).

Operating periods	Average temperature (C)
06:00 to 18:00	21
18:00 to 00:00	30
00:00 to 06:00	25

Period of operation are given in Table 5.

Table 5 installations per operating period

Depending on the client's choice, the areas were prioritized for each period of operation. The list of load shedding priorities of the customer in table 6:

Table 6 Operating periods and load shedding list

operating periods	load shedding list
06:00 to 18:00	3; 2; 4; 5; 1
18:00 to 00:00	2; 4; 5; 3; 1
00:00 to 06:00	2; 4; 5; 3; 1

This simulation showed the efficiency of the system, but it was insufficient to test and validate all the device features simulation results of the system. Another simulation with fictitious events was necessary to test everything

The results of this last simulation allowed the validation of 90% of the functionalities as illustrated by the results of the figure n ° 8, only the functionalities relating to the integration were not verified because authorization of the ONEE to inject production on the public network

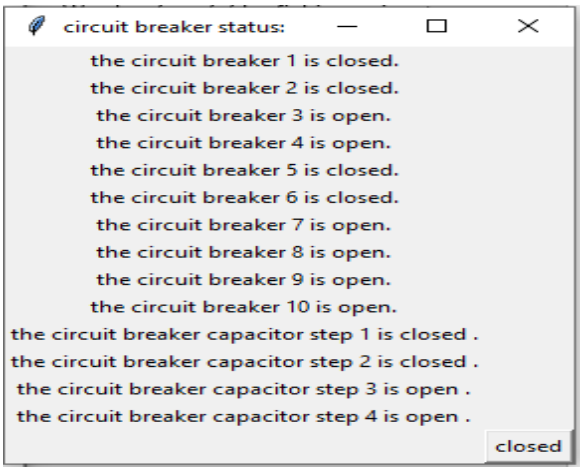

Fig. 8-a Simulation states/ operating period 06:00 to 18:00

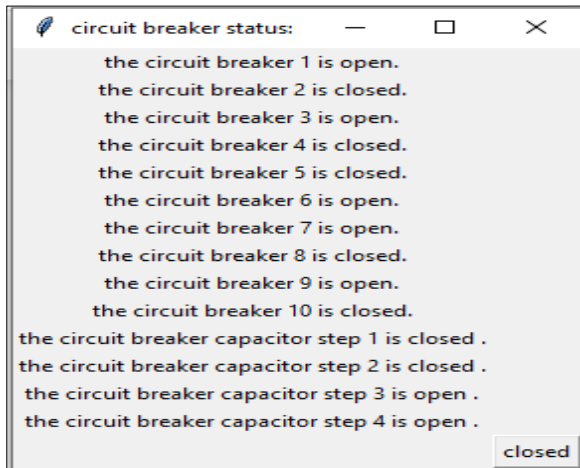

Fig.8-b simulation states /operating period 18:00 to 00:00

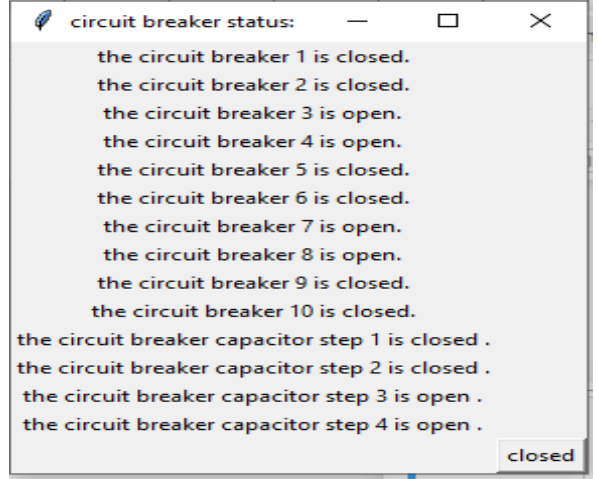

Fig. 8-c simulation states /operating period 00:00 to 08:00

The optimal power supply diagrams have been well established, the manager's instructions are followed, and the capacitor bank steps have been well controlled.

6. Conclusion

The smart grids technology represents a key solution to accompany the energy transitions initiated in many countries, at the same time, it constitutes a new lever to make competition between the producers and the distributors of electrical energy.

Our study and our simulations have allowed us to conclude that the smart grid downstream of the meter is not a comfort for the consumer producer but a management tool to minimize economic losses, optimize consumption, minimize pollution on the network, possibly reducing the bill by playing on the tariff items and by promoting competition, strengthen the security of goods and people and represents a system of assistance to the DSO to better manage the integration constraints on the network.

The provision of price elements (price, schedule) will be essential to respond effectively to requests for deletion, while taking into account the specificities (need production or comfort, private data, possibility of derogation) of the customer. This data will have to be provided directly by the meter to the different forms of equipment of the customer.

References

[1] A. Toliyat, A. Kwasinski and F. M. Uriarte, "Effects of high penetration levels of residential photovoltaic generation: Observations from field data," 2012 International Conference on Renewable Energy Research and Applications (ICRERA), Nagasaki, 2012, pp. 1-6.
 [2] Raja Masood Larik, Mohd Wazir Mustafa and Sajid Hussain Qazi, Faculty of Electrical Engineering,

- [3] ONEE-BE, « Bilan d'activités commerciales et industrielles de l'ONEE-BE 2017 », ONEE-BE, Casablanca Maroc December 2017.
- [4] Salman Mohagheghi, Fang Yang and Bamdad Falahati : Impact of demand response on distribution system reliability, Published: 09 February 2014 , <https://www.researchgate.net/publication/252049167>],1-2
- [5] A.Harrouz, M. Abbes, I. Colak and K. Kayisli, "Smart grid and renewable energy in Algeria," 2017 IEEE 6th International Conference on Renewable Energy Research and Applications (ICRERA), San Diego, CA, 2017, pp. 1166-1171.
- [6] Y. Tominaga, M. Tanaka, H. Eto, Y. Mizuno, N. Matsui and F. Kurokawa, "Design Optimization of Renewable Energy System Using EMO," 2018 International Conference on Smart Grid (icSmartGrid), Nagasaki, Japan, 2018, pp. 258-263.
- [7] Regulatory Models, California Public Utilities Commission, June 08, 2015,
- [8] S. N. Saxena, Smart Distribution Grid – and How to Reach the Goal, International Journal of Smart Grid, pp 193,-194, Vol.3, No.4, December, 2019
- [9] Seref Sagiroglu, Yavuz Canbay et Ilhami Colak, "Solutions and Suggestions for Smart Grid Threats and Vulnerabilities", International Journal of Renewable Energy Research (IJRER), Vol.9, No.4, pp 2054, December, 2019
- [10] Michael S. Moore, Ph.D., Saeed Monemi, Ph.D., Jianfeng Wang, James Marble and Steve Jones, Diagnostics and Integration in Electric Utilities, pdfs.semanticscholar.org
- [11] Paatero, J.V.; Lund, P.D. Effects of large-Scale photovoltaic power integration on electricity distribution

networks. *Renew. Energy* 2007, 32, 216–234. CrossRef

- [12] Jidong Wang, Ran and Yue Zhou: A Short-Term Photovoltaic Power Prediction Model Based on an FOS-ELM Algorithm, applied sciences, Published: 21 April 2017.
- [13] J. A. Thomas, "Optimization Method for the Clear Sky PV Forecast Using Power Records from Arbitrarily Oriented Panels," 2018 7th International Conference on Renewable Energy Research and Applications (ICRERA), Paris, 2018, pp. 117-123.
- [14] Sophie Pelland, Jan Remund, Jan Kleissl, Takashi Oozeki, Karel De Brabandere, Photovoltaic and Solar Forecasting: State of the Art, IEA PVPS Task 14, Subtask 3.1 Report IEA-PVPS T14-01: 2013 October 2013, 6-7
- [15] Julien Najac (EDF R&D), "La prévision de production éolienne et photovoltaïque à EDF", Séminaire InTech, INRIA, Grenoble, 27/09/2012, 15
- [16] Law n° 58-15 modifying and complementing law 13-09 on renewable energy. Adopted by parliament in December 2015. Promulgated by Dahir n°1-16-3 of the 12 January 2016 and published in the official bulletin.
- [17] ONEE-BE-DISTRIBUTION, "contrat d'abonnement BT", ONEE-BE, Casablanca Morocco 1963
- [18] ONEE-BE-DISTRIBUTION, "procédure exploitation et de maintenance des postes MT/BT" ONEE-BE, Casablanca Morocco
- [19] M. Chiandone, C. Tam, R. Campaner and G. Sulligoi, "Electrical storage in distribution grids with renewable energy sources," 2017 IEEE 6th International Conference on Renewable Energy Research and Applications (ICRERA), San Diego, CA, 2017, pp. 880-885.
- [20] T. Baba, Y. Mizuno, K. Fujio, Y. Tanaka and N. Matsui, "Evaluation of An Island Operation Method Smart Grid Using A Power Emulation System," 2018 International Conference on Smart Grid (icSmartGrid), Nagasaki, Japan, 2018, pp. 98-101.